

600.005

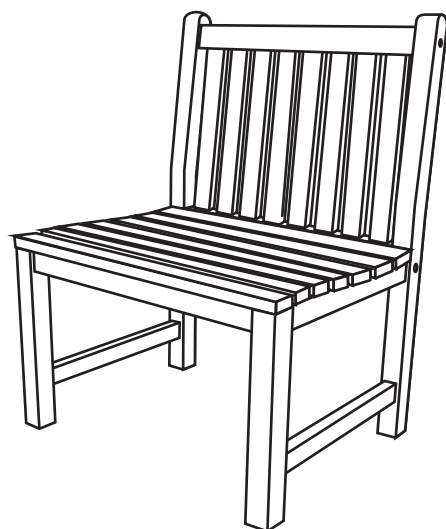
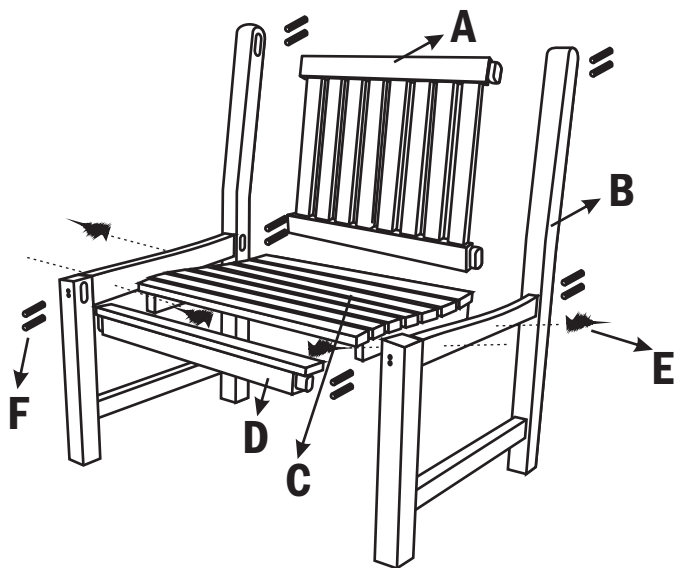

# SINGARAJA CHAIR

## 50 X 61 X 92 CM

### ASSEMBLY INSTRUCTION

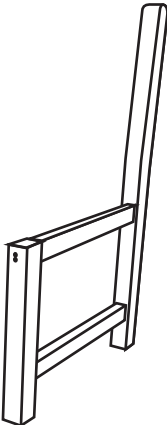
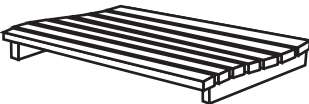

### LIST OF PARTS

POS	QTY	COMPONENT
A	1	
B	2	
C	1	
D	1	
E	4	
F	12	